

Customised Single-Use- Bioreactor

For cultivation, perfusion and fermentation
Working Volume from 100 ml to 25 liter



CellVessel
CellRider
BactoVessel
CellMiscelatore
Accessories

The CerCell logo features a stylized blue and white cell-like structure above the brand name "CerCell" in a bold, black, sans-serif font.

World only configurable Single-Use-Bioreactor (SUB)

- **CellVessel** Working Volume (WV) available from 100 ml to 25 liter in 20 steps.
- CellVessel integrates with any Process-Control-System (PCS) with standard temp, DO and pH sensor input.
- Magnetic-Stirrer-Table (MST) drive or Head-Plate-Drive (HPD) accepting any servo motor.
- 25 different spargers to choose from and any thermal control either electrical or liquid based.

**CellVessel
are
Cultivation
Ready**



World only configurable Perfusion-Ready Single-Use-Bioreactor (PR-SUB)

- **CellRider** for ATF / TFF application with Working Volume (WV) from 100 ml to 10 liter.
- CellRider portfolio (LowRider / HighRider) integrates with any Process-Control-System (PCS) with standard temp, DO and pH sensor input.
- Magnetic-Stirrer-Table (MST) drive or Head-Plate-Drive (HPD) accepting any servo motor.
- 25 different spargers to choose from and any thermal control either electrical or liquid based.
- You preferred broth pump being centrifugal, diaphragm, peristaltic installed by yourself (aseptic connections) or pre-installed by CerCell
- You preferred membrane filter as you like.
- Hollow-Fiber-Filter (HFF) installed by yourself (aseptic connections) or pre-installed by CerCell.

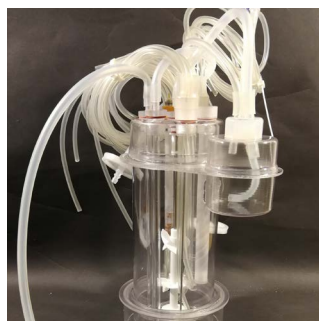

**CellRider's
are
Perfusion-
Ready**

World only configurable Single-Use-Fermenter (SUF)

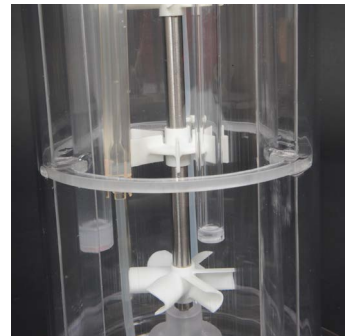
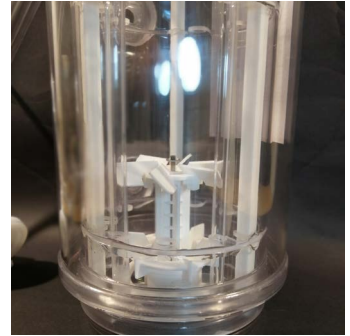

**BactoVessel
are
Fermentation
Ready**



- **BactoVessel** is all preassembled and ready to use right out of the box.
- Working volume from 200 ml to 25 liter.
- BactoVessel designed for connection to your own preferred PCS and servo motor.
- BactoVessel outlet / inlet connection with long silicone hoses and connectors.
- Exhaust gas cooler if preferred.
- Fully customized baffel design.
- Single-Use-Sensor's (SUS) as required (and available).
- Adapts to any electrical or liquid thermal control system.
- Check out more details and accessories from page 5.

World only configurable mini-SUB

- **CellVessel** SUB's size 500 ml VV.
- SUB available with any type of impeller.
- Agitation by Magnetic-Bottom-Drive (MBD) on Magnetic-Stirrer-Table (MST) driven by any servo motor.
- Range of Single-Use-Sensor's with connectors which fit your PCS.
- Highly efficient thermal control.

Mini
CellVessel are
Cultivation
Ready

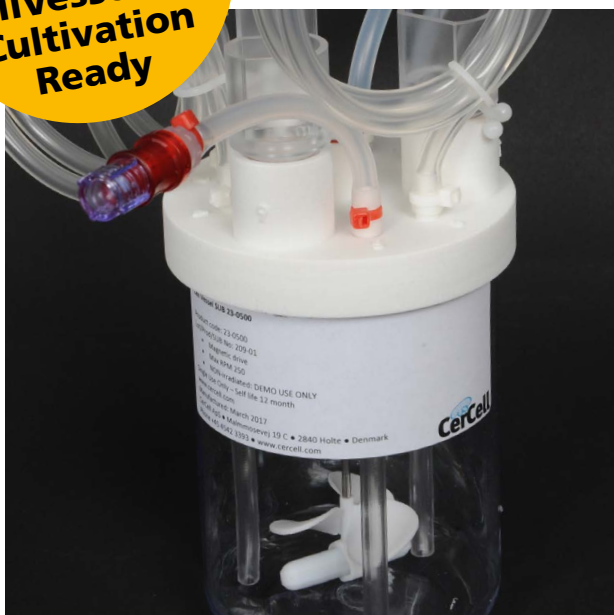

CerCell offer to design and manufacture any type of CellMiscelatore™ Single-Use-Mixer (SUM) you may require.

Vessel Volumes from 500 ml and up to 13 liter. Available with many different impellers, with or without stator and all for MST drive. Minimum Working Volume determined by the type of sensor's (SUS) you plan to use.

The **CellMiscelatore™** is a customized product and we need to interact, listen to your requirement before we can give you a quote.

World only configurable Single-Use-Mixer (SUM)



Process-Control-System's (PCS) in play

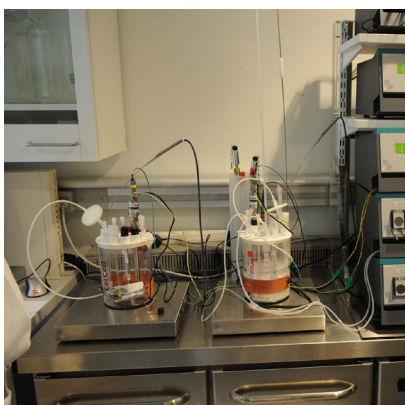
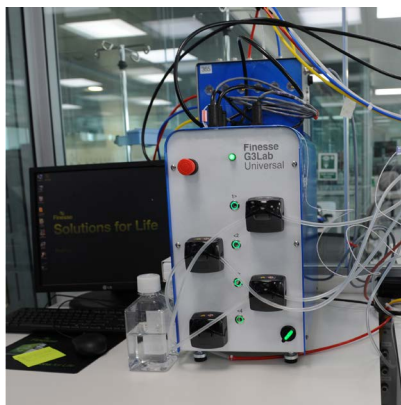

**CerCell
adapts
products
for an easy
installation**

PCS servo motor's

CerCell SUB's, PR-SUB's, SUF's, MST and accessories adapts easily to the many different servo motors used by PCS manufactures.



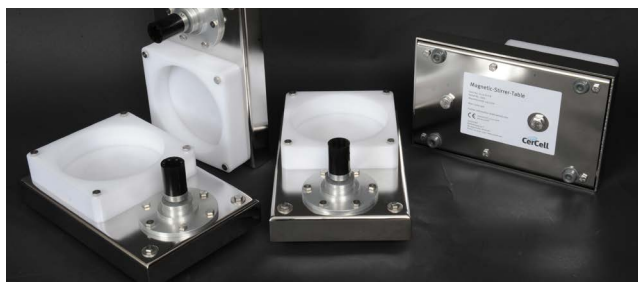

Magnetic-Stirrer-Table drive (MST) with servo motor

- CellVessel in size 500 ml to 13,5 liter is suitable for Magnetic-Bottom-Drive
- SUB's with Magnetic-Bottom-Drive is the most stable and easy setup on the Magnetic-Stirrer-Table driven by any servo motor.
- No heavy servo motor on the light weight SUB's.
- More space on head plate for sensors.
- Any number, type, size, and mix of impeller's and turbine's.

It's all Plug & Play!

Magnetic-Bottom-Drive offer light weight SUB speed and power without the need of adding the somewhat heavy servo motor.

Though the heavy servo motor allow turbine rotation and power to be distributed by turbines inside the media.

Magnetic-Stirrer-Table (MST) gives simplicity

Head-Plate-Drive (HPD) with servo motor

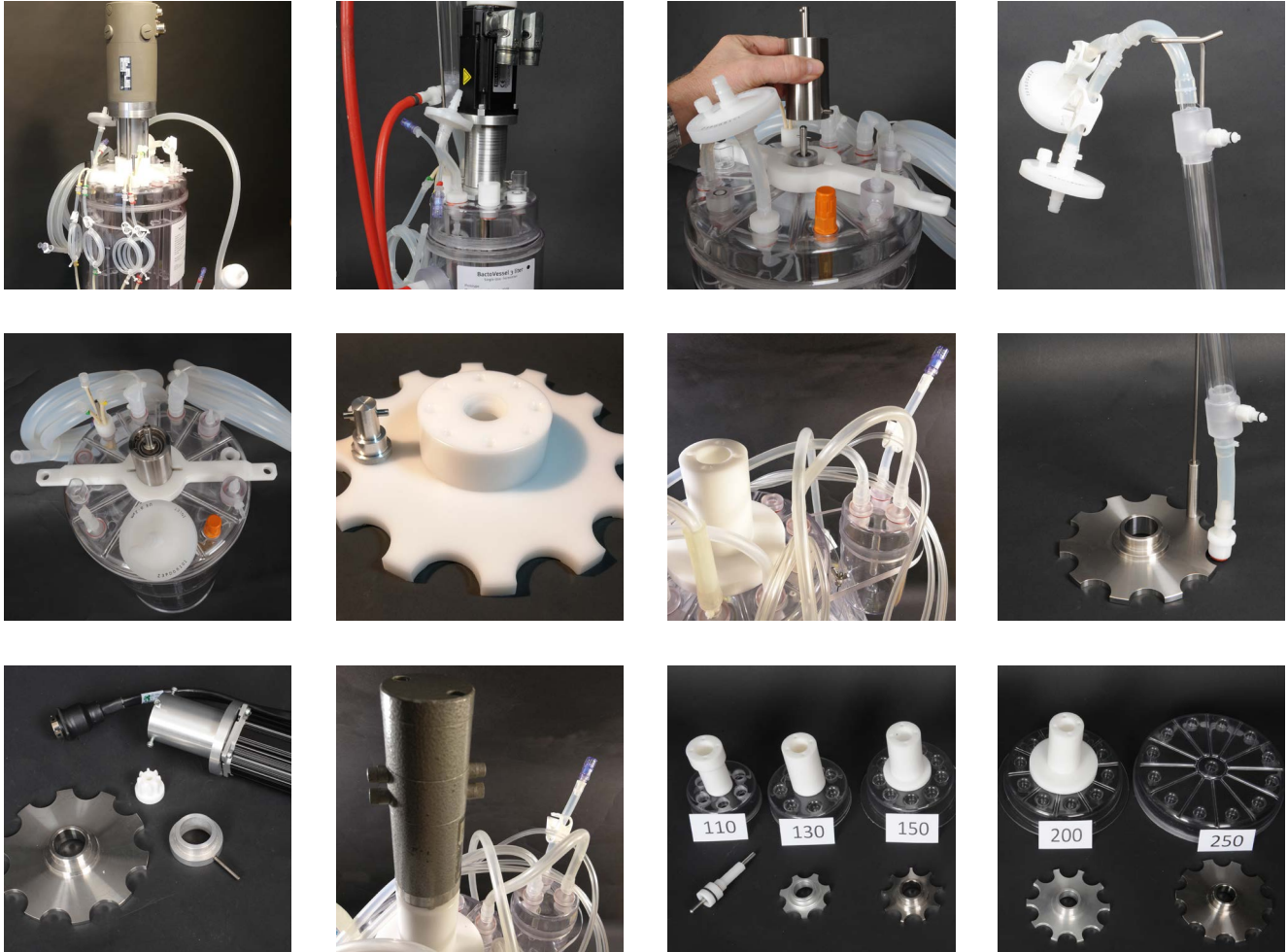

- CellVessel in size 10 to 30 liter is suitable for servo motor mounted on the head plate.
- Head-Plate-Driven agitation (HPD) for any servo motor with a range of adaptors.
- Any number, type, size, and mix of impeller's.

Head-Plate-Drive require some SUF weight and size in order to carry the somewhat heavy servo motor.

Though the heavy servo motor allow turbine rotation up to 1.500 RPM and immense power to be distributed by turbines inside the media.

It's all Plug & Play!

Head-Plate-Drive (HPD) gives BactoVessel power and speed

Single-Use-Sensor's (SUS)

Pre-installed SUS measures DO, pH, bio-mass, level, conductivity, temperature

The complete CerCell SUB/SUF family optional may include through the head-plate vertically mounted, pre-installed Single-Use-Sensor's (SUS).

Depending on SUB size even **PICO Futura** SUS capacitance bio-mass SUS mounted vertical through head plate or horizontal at bottom. For accurate DO measurements we pre-install either **VisiWell** or **PolarWell**. Use the optical or polarographic Re-Usable-Sensor.

(RUJ) supplied with your PCS. For pH measurements your PCS standard cabling offer either AK9 or AS8 connector. Easy connection to the pre-installed **pH SUS** made from glass or polymer. Std. **temperature sensor** goes into the non-invasive well. ConducCell is a high precision **conductivity** and Pt1000 SUS.

It's all Plug & Play!



Impellers for agitation

CellVessel impeller's are designed with a set of identical blades attached to the central core, shaft.

CerCell offer 650 different impeller design. All described via principle, diameter, blade angle and number of blades.

- Suitable for Magnetic-Stirrer-Table driven (MST) agitation.
- Suitable for Head-Plate-Drive agitation (HPD) agitation.
- Any number, type, size, and mix of impeller's and turbine's.
- Radial or axial agitation as desired.
- View our agitation movies: www.cercell.com/support/cellvessel-details.



Turbines for agitation

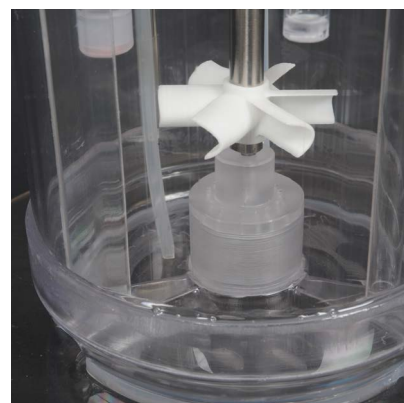
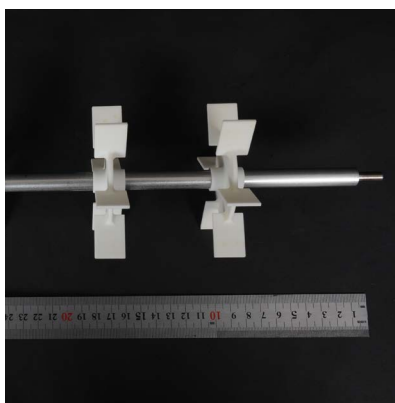
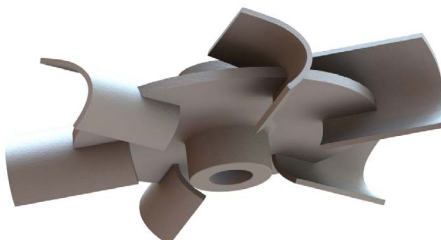
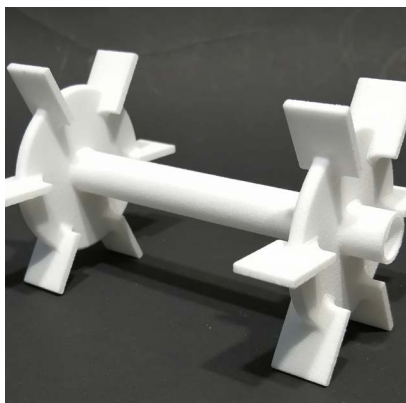
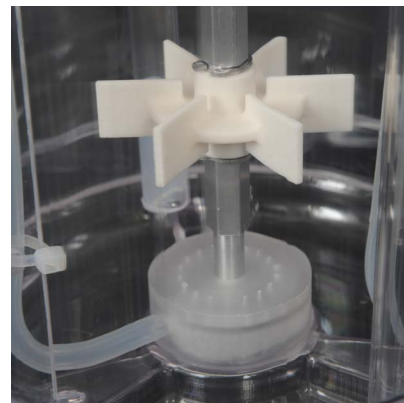

CerCell offer different turbine principles: Rushton, Jacobs, Smith, Hjort and Bakker. All with identical basic dimensions:

- Any drive method, number, type, size, and mix of turbine's is possible to integrate in the SUF.
- Outside Diameter, OD mm: 40, 50, 60, 70, 80, 90, 100 and 120.

- Blade shape: flat, symmetric half circle, symmetric elliptical, asymmetric elliptical.
- Flat blades may be angled in 75 degree from vertical like Jacobs turbine.
- Agitation up to 2.000 rpm.
- Dimension of turbine and blade designed is free.
- Some 150 turbines is available!

Pores for aeration

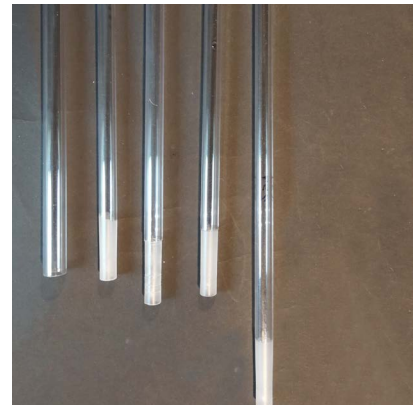
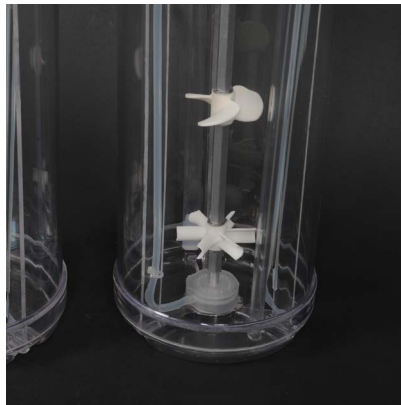
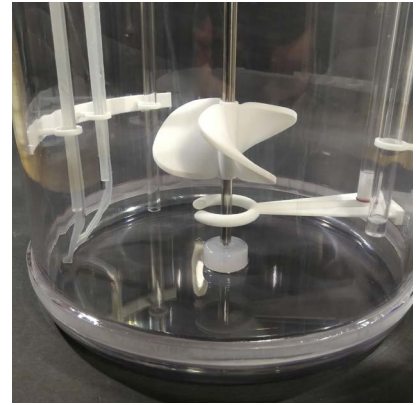
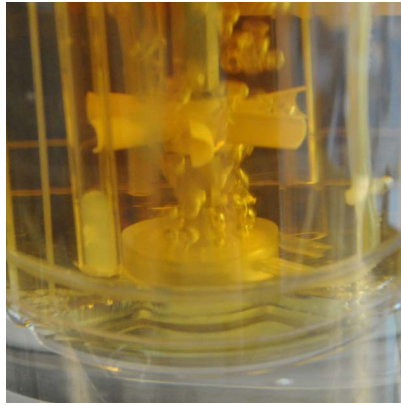

- For bubble generations its all about material pore size and material surface properties.
- Get as many of the bubbles and of the size you want.
- Arrange the aeration device you know works best for your application and where you want.
- Choose from hundreds of different sparger bodies for your own testing and approval.



Electrical heating

- Electrical-Heating-Blanket (EHB) surrounding any of the CellVessel, BactoVessel, CellRider's from 2,1 liter Vessel Volume (VV) to 30 liter VV.
- EHB comes in a range of sizes and voltages – cable adaptors available for any PCS.

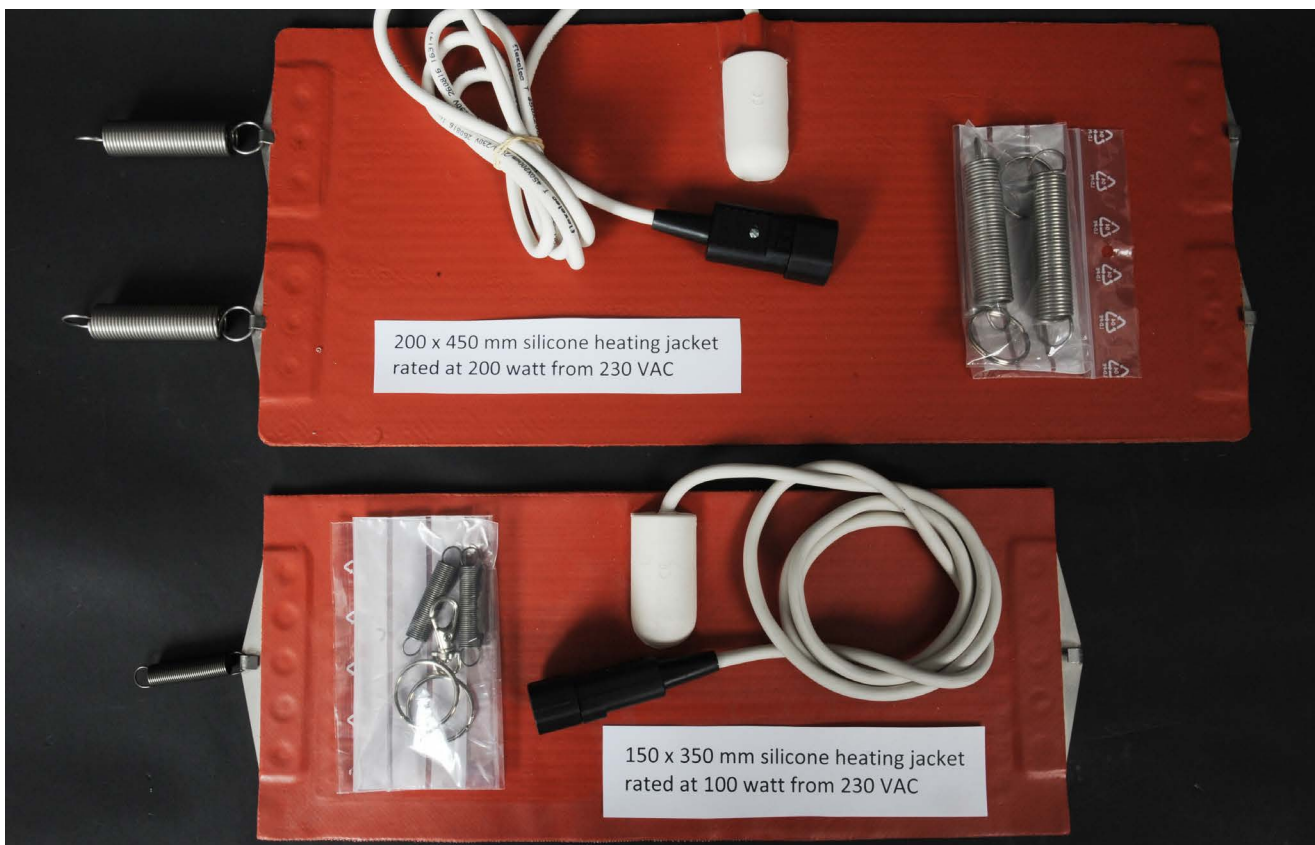

External liquid heated



Re-Usable-Jacket (RUJ) for Cell-Vessel or BactoVessel offer easy use with liquid controlled Process-Control-System.

- The RUJ-MST is designed for integration with Magnetic-Stirrer-Table (MST).
- Available in several sizes covering 2,1 liter up to 7,3 liter SUB.

Integrated liquid cooling

It's all Plug & Play!



Some Process-Control-System (PCS) facilitating thermal control by recirculating liquids. The optional integrated Single-Use-Jacket (SUJ) heat exchanger is an efficient option for BactoVessel.

- Best possible heat transfer.
- Connects to any PCS thermal control.
- Available for Head-Plate-Drive (HPD) and in sizes from 3,2 to 30 liter VV.

Compact thermal control

Heating-Support-Foot (HSF)

The best thermal control for all
3.200 ml VV size vessel's

Heating-Support-Foot (HSF) that fits any of the OD137 mm / 3.200 ml vessel's. HSF is able to operate with small volumes starting from few hundred ml up to 2.000 ml. Very easy installation of HighRider-2 and even LowRider-2 with horizontal broth exit at bottom.

Whatever happens ...

You can run the PR-SUB dry, forget media, thermo couple fall out, PCS breaks down ... this advanced HSF will never destroy the PR-SUB and leak out media or burn your fingers when trying to solve the problem!

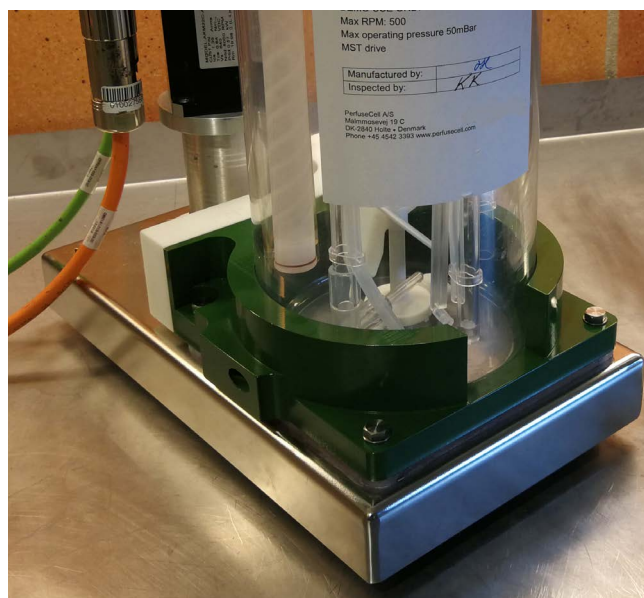

These 4 in parallel operating MST can handle 500 ml as well as 3.200 ml WV SUB's or PR-SUB's in only 80 cm table space controlled by any PCS you may have.

CellRider Hollow-Fiber-Filter (HFF)

Separates at only 0,2 μm

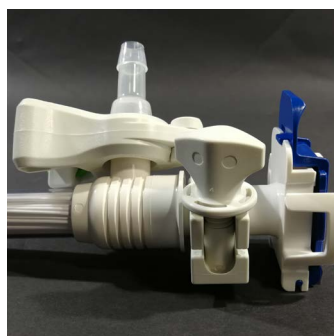
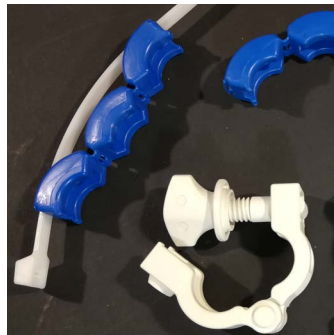
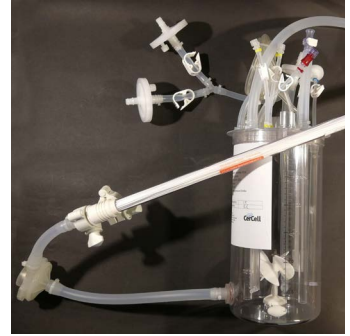

Cross Flow Filtration is an efficient method for filtration and separation of solutions containing biomolecules, or particles such as viruses, bacteria or cellular material.

It is a process whereby product flow (broth feed) is directed inside the multiple straw / tube shaped membranes with most of the solution as retentate circulated back into the SUB. A minimum of the broth feed pass tangentially across the membrane as permeate.

The rapid flow of broth along the membrane acts to 'sweep' the surface, reducing concentration polarization. It also prevents build-up of foulants that can plug the pores at the membrane surface. The rapid cross flow creates a pressure drop, which forces some of the feed solution and dissolved molecules that are smaller than the pores in the membrane, through the membrane filter as permeate.

The solution that passes through the membrane is referred to as filtrate or permeate. Molecules or particles larger than the membrane pores are retained in the feed, broth and effectively concentrated in the SUB.

CellRider broth / media exchange

CellRider family works with your preferred centrifugal, membrane or peristaltic pump. You assemble as needed or CerCell deliver complete package = no need for the hood!

SUP Single-Use-Pump

Your preferred Single-Use-Pump combined with your HFF and the CellRider PR-SUB. Freedom to choose the pump you prefer. Being centrifugal or peristaltic or diaphragm.



CellRider centrifugal pumps

Pre-assembled with Levitronix Single-Use-Pump with or without Hollow-Fiber-Filter module. You assemble as needed or CerCell deliver complete package = no need for the hood!

www.levitronix.com/en/pumps.html



Customized SUB / SUF all by yourself

Build your own SUB or SUF exactly to your needs ... all by yourself. Use the world's only on-line Configurator Tool!

We have more than 2.000 components designed to fit each other. That's millions of combinations!

All parts are Plug & Play!



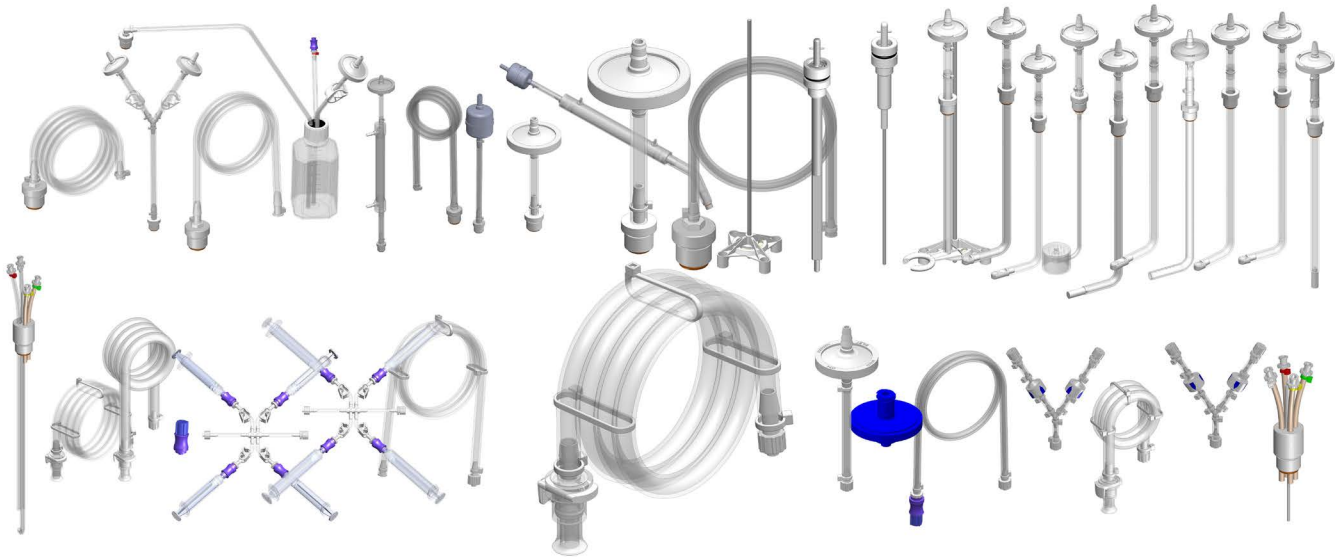

Configurator Tool – Do It Yourself!

The "Configurator Tool" is world only "Do-It-Yourself" SUB and SUF product. The purpose of the DIY tool is to simplify the SUB and SUF design phase. After all you can choose from

+5.000 different components on the shelves at CerCell. The tool collects all your choices and presents the result as a long product code in a PDF file to save and print out.



Plug & Play Accessories

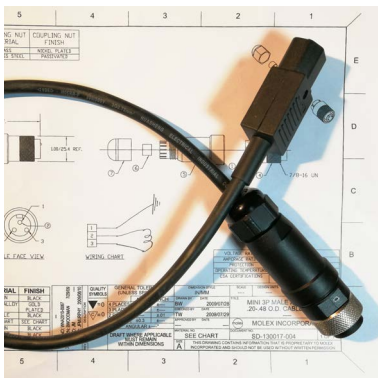
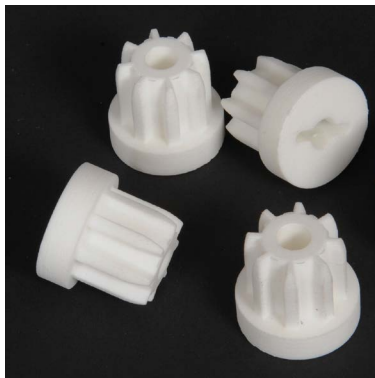

Sterile filter heater
Circular filter max OD50 mm / 16 cm2
pn# 2211

Sterile filter heater
Circular filter max OD65 mm / 21 cm2
pn# 2212

**Find all
the information
you need here**

www.CerCell.com



CerCell Aps
Malmlosevej 19C
DK-2840 Holte
Denmark

www.cercell.com
phone +45 45423393
info@cercell.com

Specifications subject to change without notice.
Please refer to www.cercell.com/intellectual-property-rights
regarding IPR, registrations and trademark.
© CerCell Aps 2019